

www.srtyolmak.com



www.srtyolmak.com



YOL YAPIM MAKİNALARI





mk10 sathi kaplama micir hazırlama eleđi

Makınamızda 33 kv jeneretör bulunmaktadır
Sathi kaplamada kullanılacak micirı dizayın ve temizlemesi için imal edilmiştir
Saatteki üretim kapasitesi 70-150 ton /saattir
Yıkama sistemi mevcuttur
Susuz durumlarda hava ilre temizleme yapmaktadır
Asıl ürünü direk araçlara yükleyerek malzemenin yeniden tozlanmasını engellemektedir
Emisyon yapımında malzemenin ısıtılmasını aynı zamanda belirli dereceye kadar ısıtıl-
(masını sağlamaktadır (işteđe bađlı
Makınanın kurulum süresi maksimum 5 dakikadır
Her türlü kamyonla çekilebilir saate 50 km hızla yolda seyahat edebilir
Malzemeler tamamen st 52 malzemedен imal edilmiştir
Makınanın ağırlığı yaklaşık 10 tondur
Tekerleklerle gelen yuk miktarı 4500 kg dir
Bütün hareketli parçaları hidroliktir bir adet toz banti için elektrikli vinç vardır
Bunker kapasitesi 7 m3 tür

MK10(gravel screening machine for asphalt)

A wonderful way to understand and appreciate a culture is by casting a curious eye upon how food is prepared and served. Great civilizations create grand cuisin
A wonderful way to understand and appreciate a culture is by casting a curious eye upon how food is prepared and served. Great civiilA wonderful way to understand and appreciate a culture is by casting a curious eye upon how food is prepared and served.
Great civilizations create grand cuisin
A wonderful way to understand and appreciate a culture is by casting a curious eye upon how food is prepared and served. Great civiil

Дорожная подметальная машина

Отличный способ понять и оценить культуру - это бросить любопытный взгляд на то, как готовят и обслуживают пищу. Великие цивилизации создают великую кухню
Отличный способ понять и оценить культуру - это бросить любопытный взгляд на то, как готовят и обслуживают пии творятОтличный способ понять и оценить культуру - это бросить любопытный взгляд на то, как готовят и обслуживают пищу. Великие цивилизации создают великую кухню
Отличный способ понять и оценить культуру - это бросить любопытный взгляд на то, как готовят и обслуживают пии творят



Дорожная подметальная машина

Отличный способ понять и оценить культуру - это бросить любопытный взгляд на то, как готовят и обслуживают пищу. Великие цивилизации создают великую кухню

Отличный способ понять и оценить культуру - это бросить любопытный взгляд на то, как готовят и обслуживают пии творят
Отличный способ понять и оценить культуру - это бросить любопытный взгляд на то, как готовят и обслуживают пищу. Великие цивилизации создают великую кухню
Отличный способ понять и оценить культуру - это бросить любопытный взгляд на то, как готовят и обслуживают пии творят



ERTUĞRUL (DERE KUMU ELEME MAKİNASI)

- .Dere malzemesinden 3 çeşit ürün elde etmek için üretilmiştir
- Elek boyutları 3300mm x 1300mm x 2
- Yükleme hazne kapasitesi 7 m³
- .Ağırlık yaklaşık 12000 kg'dır
- .Enerjisini 70 Kw'lık bir jeneratörden almaktadır
- .Yıkama sistemi mevcuttur
- .Montajı çok kolaydır ve kısa zamanda yapılmaktadır
- .Her türlü kamyon arkasında seyahat edebilir
- .Maximum hızı saate 40 km dir
- .Malzeme beslemesi için hız ayarı bulunmaktadır
- .Ağırlık artırılabilir
- .Bütün konveyörleri hidrolik sistem kullanılarak açılır ve toplanır

ERTUĞRUL (NATURAL SAND SCREENING MACHINE)

A wonderful way to understand and appreciate a culture is by casting a curious eye upon how food is prepared and served. Great civilizations create grand cuisin
A wonderful way to understand and appreciate a culture is by casting a curious eye upon how food is prepared and served. Great civi
A wonderful way to understand and appreciate a culture is by casting a curious eye upon how food is prepared and served. Great civilizations create grand cuisin
A wonderful way to understand and appreciate a culture is by casting a curious eye upon how food is prepared and served. Great civi

STONE CRUSHING MACHINE

🇬🇧 K-1200 mobile primary crushing unit

A wonderful way to understand and appreciate a culture is by casting a curious eye upon how food is prepared and served. Great civilizations create a wonderful way to understand and appreciate a culture is by casting a curious eye upon how food is prepared and served. Great civilizations create a wonderful way to understand and appreciate a culture is by casting a curious eye upon how food is prepared and served. Great civilizations create a wonderful way to understand and appreciate a culture is by casting a curious eye upon how food is prepared and served. Great civilizations create



TAŞ KIRMA MAKİNASI

🇹🇷 k-1200 mobil Primer kırma eleme ünitesi

kapasite 200-300t/h

Elektrik sarfiyat 250 kw/h

Toplam Güç 250kw

Yükseklik 4400mm

Genişlik 3600mm

Uzunluk 16000mm

Bant sayısı 6 adet

Elek 1600.5000.2

Bunker hacimi 16 m3

Toplam ağırlık 50 ton

özellikler: Makinemiz uzaktan kumandalı üç dingil Dorse üzeri, Altı adet hidrolik ayak sabitleme ve 1600 ton hareketli stok bandına Sahiptir.

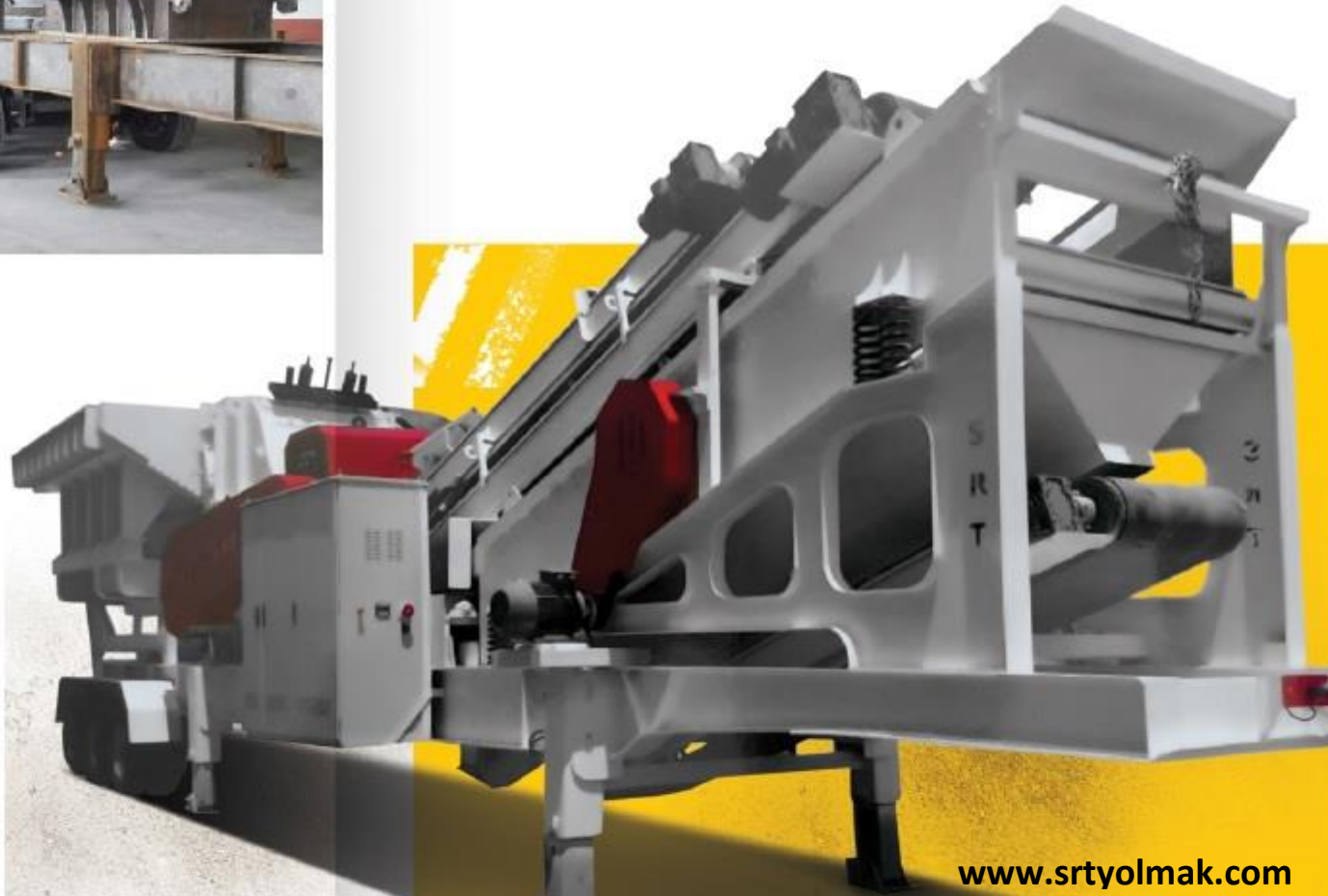

TAŞ KIRMA MAKİNASI (SEKONDER)



🇹🇷 K-960 TAŞ TOZU ÜRETME MAKİNASI

tip k-960
Kapasite 100-150 ta/h
Yükseklik 4.5M
Genişlik 2.35 M
Uzunluk 5.00M
Motor gücü 110 KW
Besleme boyutu 05-200 mm

🇷🇺 ВТОРИЧНАЯ ДРОБИЛКА

ВИДЫ: K-960
ЕМКОСТЬ: 75 - 100 t / h
ВЫСОТА : 4,5 М
ШИРИНА : 2,35М
ДЛИНА : 5 М
РАЗМЕР ЗАГРУЗКИ : 05 - 200 mm
СИЛА ДВИГАТЕЛЯ :110-200 kw



SECONDARY CRUSHER

🇬🇧 STONE POWDER PRODUCTION MACHINE

tip k-960
Kapasite 100-150 ta/h
Yükseklik 4.5M
Genişlik 2.35 M
Uzunluk 5.00M
Motor gücü 110 KW
Besleme boyutu 05-200 mm





🇹🇷 Trafik Levha Direği Ve Çtp Çakma Aracı

- .Aracımız 2, 3 veya 4 tonluktur
- .Üstten çakım yüksekliği maksimum 5 m'dir
- .Personeli levha montaj seviyesine kadar kaldırarak levha montajını kolaylaştırır
- .Vincin ucuna sepet takılabilir
- .180°-350° dönüş açısına sahiptir
- .İki noktadan yere basar ve sabitler
- .Kumanda vincin yanındaki hidrolik levyelerde yapılır
- .Montaj yeri kabin arkasına yada aracın arka şasesinde yer alır
- .Bsk zeminlere ve kışlı zeminlere çakım yapabilir
- .Çakım derinliği maksimum 1500 mm'dir

🇬🇧 Vehicle to set traffic signs and barriers

A wonderful way to understand and appreciate a culture is by casting a curious eye upon how food is prepared and served. Great civilizations create grand cuisin
A wonderful way to understand and appreciate a culture is by casting a curious eye upon how food is prepared a

🇷🇺 Дорожная подметальная машина

Отличный способ понять и оценить культуру - это бросить любопытный взгляд на то, как готовят и обслуживают пищу. Великие цивилизации создают великую кухню
Отличный способ понять и оценить культуру - это бросить любопытный взгляд на то, как готовя





🇬🇧 Asphalt repair tool

A wonderful way to understand and appreciate a culture is by casting a curious eye upon how food is prepared and served. Great civilizations create grand cuisin
A wonderful way to understand and appreciate a culture is by casting a curious eye upon how food is prepared and served. Great civilizations create grand cuisinA wonderful way to understand and appreciate a culture is by casting a curious eye upon how food is prepared and served. Great civilizations creata curious eye upon how food is prepared and served. Great civilizations creat

🇷🇺 Инструмент для ремонта асфальта

Отличный способ понять и оценить культуру - это бросить любопытный взгляд на то, как готовят и обслуживают пищу. Великие цивилизации создают великую кухню
Отличный способ понять и оценить культуру - это бросить любопытный взгляд на то, как готовят и обслуживают пищу. Великие цивилизации создают великую культуру.
Отличный способ понять и оценить культуру - это бросать любопытный взгляд на то, как готовят и обслуживают пищу. Великие цивилизации творят



🇬🇧 ASFALT BAKIM ARACI

Bu aracımız işlevine göre farklılık gösteren yapıdadır. Bunlar ısıtmalı, ısıtmaz ve vinçli ısıtmalı, vinçsiz ısıtmalı olarak ayrılır
.Kapasiteleri montaj edilecek araca göre 7m³ ile 17 m³ arasında değişebilir
. Bütün yama araçlarımız çift cidarlıdır
.Isıtmalı araçlarımız, kuru hava ısıtmasına sahiptir
Asfalt bakım araçlarımızda 50 mm taşıyününe bulunmaktadır. Malzemenin .sıcaklığını hava şartlarına bağlı olarak 24 saat korur
Bütün bakım araçlarımızda 150 - 230 lt aştar tankı mevcuttur. Aştar .tanklarımızda hidrolik pompa mevcuttur
Araç içeriden veya aracın arkasından kumanda edilebilir veya talep durumunda uzaktan kumanda takılabilir
.Boşaltma hızı dakikada 450 kg ile 1000 kg arasındadır
Silindir Yükleme Vinci 3000 kg'dır. Vinçli araçlarımız yama silindiri taşımak için kullanılır



🇹🇷 KAMYON ÖNÜ KAR KÜREME BIÇAĞI

Makinamızın boyu; kamyonun taşıma kapasitesine göre 2400 mm ile 3000 mm arasında değişir
.adet yüksek dayanımlı çelik bıçak ve 8 adet yüksek 4 .dayanımlı yaydan yapılmıştır
.Her türlü kamyon ve kamyonete takılabilir
.Gövde ve yönlendirme paneli polikarbon dur
Gücünü araca bağlı DC ünitesinden ya da aracın kendi hidrolik .sisteminden alır
.Dönüş açısı 22°-27°'dir
.Maksimum çalışma hızı 60 km'dir
.Vibrasyonu alması için hidrolik akü kullanılmıştır
.Kumanda; arac içinden elektronik kumanda ile yapılmaktadır

🇬🇧 Snow plow blade

A wonderful way to understand and appreciate a culture is by casting a curious eye upon how food is prepared and served. Great civilizations create grand cuisin

A wonderful way to understand and appreciate a culture is by casting a curious eye upon how food is prepared and served. Great civill



🇷🇺 лезвие снегоочистителя

Отличный способ понять и оценить культуру - это бросить любопытный взгляд на то, как готовят и обслуживают пищу. Великие цивилизации создают великую кухню
Отличный способ понять и оценить культуру - это бросить любопытный взгляд на то, как готовят и обслуживают пии творят





СНЕГООЧИСТИТЕЛЬ

Отличный способ понять и оценить культуру - это бросить любопытный взгляд на то, как готовят и обслуживают пищу. Великие цивилизации создают великую кухню
Отличный способ понять и оценить культуру - это бросить любопытный взгляд на то, как готовят и обслуживают пии творят



BACKHOE LOADER KAR KÜREME BIÇAĞI

.Bu makinamızın boyu 3000 mm, yüksekliği 800 mm ve bıçak sayısı 4 adettir
Yönlendirme paneli 8mm, ana gövde 10 mm ve bıçakları 10-12 mm yüksek dayanımlı çelik-ten imal edilmiştir
.Her türlü bekoloder iş makinalarına takılabilir, sağa sola (23°-27°) dönebilir
.Bıçakları panele 20 mm, 9-11 bükümlü yayla monte edilir
.Rögar kapaklarına çarpmadan dolayı araca ve rögara her hangi bir şekilde zarar vermez



backhoe loader snow plow blade

A wonderful way to understand and appreciate a culture is by casting a curious eye upon how food is prepared and served.
Great civilizations create grand cuisin
A wonderful way to understand and appreciate a culture is by casting a curious eye upon how food is prepared and served.
Great civilizations create grand cuisinA wonderful way to understand a

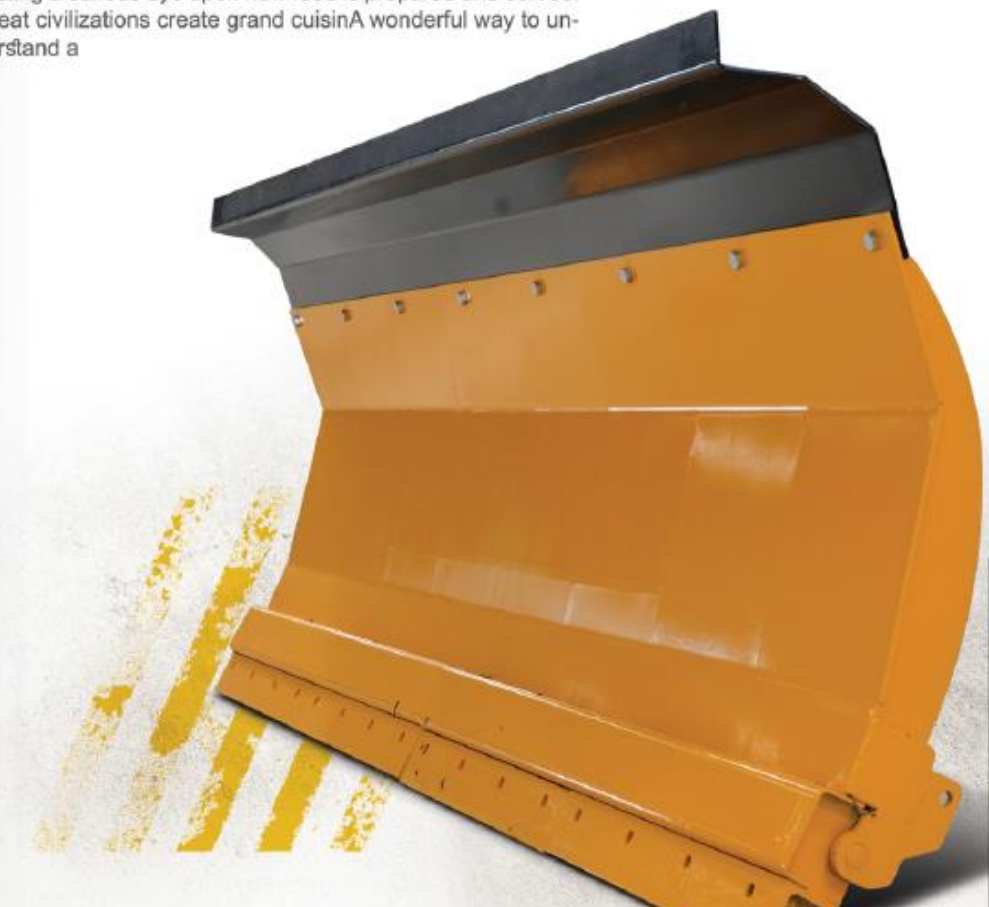

Tractor snow plow attachment

A wonderful way to understand and appreciate a culture is by casting a curious eye upon how food is prepared and served. Great civilizations create grand cuisin
A wonderful way to understand and appreciate a culture is by casting a curious eye upon how food is prepared and served. Great civilizations create grand cuisin
A wonderful way to understand and appreciate a culture is by casting a curious eye upon how food is prepared and served. Great civilizations create a curious eye upon how food is prepared and served. Great civilizations creat

Навесное снегоборочное оборудование

Отличный способ понять и оценить культуру - это бросить любопытный взгляд на то, как готовят и обслуживают пищу. Великие цивилизации создают великую кухню
Отличный способ понять и оценить культуру - это бросить любопытный взгляд на то, как готовят и обслуживают пищу. Великие цивилизации создают великую культуру.
Отличный способ понять и оценить культуру - это бросать любопытный взгляд на то, как готовят и обслуживают пищу. Великие цивилизации творят

Traktör Onu Kar Kurume Bıcağı

- .Makinemiz her türlü traktöre takılabilir
- .Geniřliđi 2000 mm ile 3000 mm aralıđındadır
- .Hareket gücünü kuyruk miline bađlı pompadan ya da traktörün kendi hidroliđinden alır
- .Gövde polikarbon panelden oluşur
- .Kalınlıđı 4-8 mm dir
- .Bıçak sayısı boyuna göre 3 veya 4 adet olmak üzere yaylıdır
- .Bıçaklar 10-12 mm yüksek dayanımlı çelikten imal edilmiştir
- .Kabin içinden hidrolik levyelerle kumanda edilir

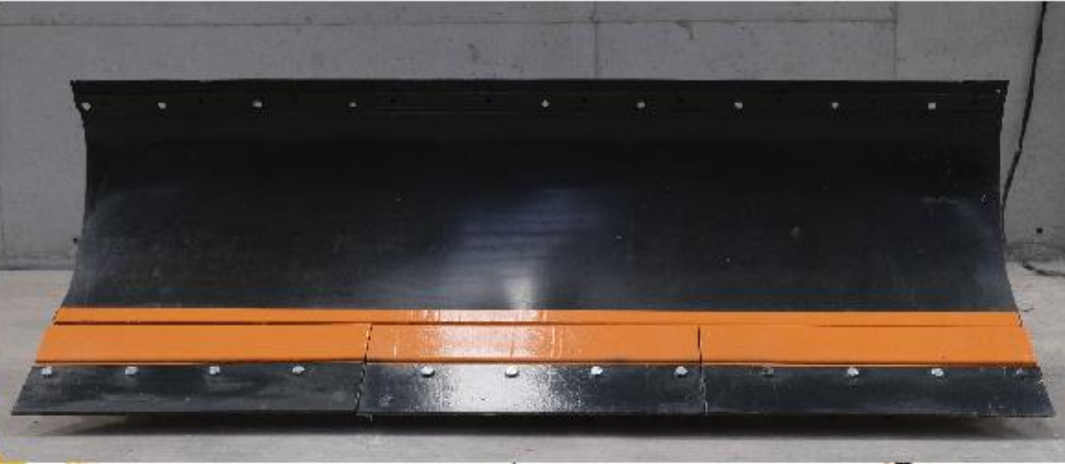

🇬🇧 Road Sweeper

A wonderful way to understand and appreciate a culture is by casting a curious eye upon how food is prepared and served. Great civilizations create grand cuisin

A wonderful way to understand and appreciate a culture is by casting a curious eye upon how food is prepared and served. Great civilizations create grand cuisinA wonderful way to understand and appreciate a culture is by casting a curious eye upon how food is prepared and served. Great civilizations create a curious eye upon how food is prepared and served. Great civilizations creat

🇷🇺 подметальная машина

Отличный способ понять и оценить культуру - это бросить любопытный взгляд на то, как готовят и обслуживают пищу. Великие цивилизации создают великую кухню
Отличный способ понять и оценить культуру - это бросить любопытный взгляд на то, как готовят и обслуживают пищу. Великие цивилизации создают великую культуру. Отличный способ понять и оценить культуру - это бросать любопытный взгляд на то, как готовят и обслуживают пищу. Великие цивилизации создают



🇹🇷 Yol Süpürgesi

- .Her türlü araca takılabilir
- .Boyu 1500 mm ile 3000 mm arasındadır
- .Süpürge çapı 380 mm ile 800 mm arasındadır
- .Araç gücünü bağlı bulunduğu aracın hidrolik sisteminden almaktadır
- .Tozuma yapmaması için su püskürtme aparatı ayrıca takılabilir
- .Sağa ve sola 22°-27°açı ile dönebilir
- .Araç içerisinde elektrikli kumanda ile kumanda edilir
- .Fırçaları ince lif, kalın lif yada çelik lif olarak ihtiyaca göre takılabilir
- .Süpürge kullandığımız araçlara istenildiğinde Kar Küreme aparatıda takılabilir

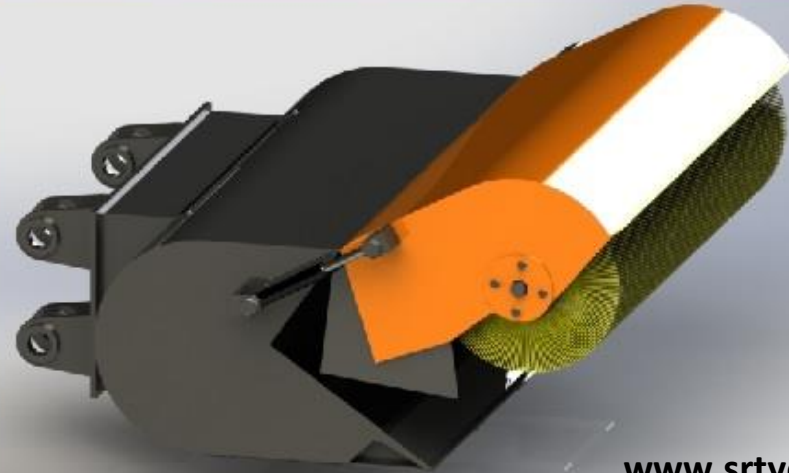
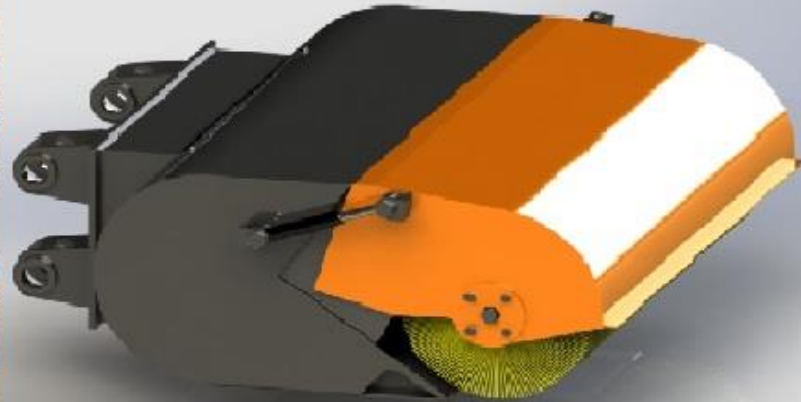

**BECOLOADER ÇÖP
TOPLAMA HAZNELİ
SÜPÜRGE**

ÇAP : 600mm

BOY : 2200mm

ÇÖP HAZNESİ : 0,7 m3

www.srtyolmak.com



SOLÜSYON SERİCİ
KAPASİTE: 2000-9000 LT
ÇIKIŞ HIZI :40 BAR
SERİM HIZI :DAKİKADA 70 LT
ŞEHİR İÇİ KALDIRIMLAR İÇİN EL TABANCA SİSTEMLİ
POMPA: 3 KAFALI MEBRAN POMPA
TAHRİK: BENZİNLİ MOTOR - ARAÇTAN HİDROLİK TAHRİK



 SOLUTION SPREADER
CAPACITY: 2000-9000 LT
OUTPUT SPEED: 40 BAR
SPREADING SPEED: 70 LT IN MINUTES
HAND GUN SYSTEM FOR IN-CITY PAVEMENTS
PUMP: 3 HEAD MEBRAN PUMP
DRIVE: GASOLINE ENGINE - VEHICLE HYDRAULIC DRIVE

 РАСПРЕДЕЛИТЕЛЬ РЕШЕНИЯ
ЕМКОСТЬ: 2000-9000 LT
ВЫХОДНАЯ СКОРОСТЬ: 40 БАР
СЕРИМ ХИЗИ: ДАКИКАДА 70 LT
ЭХИРИ ИЛИ КАЛДИРИМЛАР В ЭЛЬ-ТАБАНКЕ СИСТЕМЛИ
ПОМПА: 3 КАФАЛИ МЕБРАНСКИЙ ПОМПА
ПРИВОД: БЕНЗИНОВЫЙ ДВИГАТЕЛЬ - АВТОМОБИЛЬ ГИДРАВЛИЧЕСКИЙ ПРИВОД



Машина для разбрасывания соли

Отличный способ понять и оценить культуру - это бросить любопытный взгляд на то, как готовят и обслуживают пищу. Великие цивилизации создают великую кухню
Отличный способ понять и оценить культуру - это бросить любопытный взгляд на то, как готовят и обслуживают пин творят



ТУЗ SERPME MAKİNASI

.Araçlarımız çift yada tek cidarlıdır
Çift cidarlı araçlar 30 mm taşıyıcıdır. Aşırı soğuk bölgelerde tuzun donmamasını sağlar ve araç içinde hazır bekletilebilir
Kapakları akordiyon çadırı veya ısı yalıtımlı hidrolik kapaklıdır
.Tuz serpme genişliği ve tuz miktarı aynı anda kumanda edilir
.Araçımızda helizonludur
Tuz serpme makinesi güç aktarımı redüktör ve hidromotor yardımıyla sağlanmaktadır

Salt Spreading Machine

A wonderful way to understand and appreciate a culture is by casting a curious eye upon how food is prepared and served. Great civilizations create grand cuisin wonderful way



HİDROLİK SIKIŞTIRMALI ÇÖP KASASI



Hidrolik Sıkıştırıcı Çöp Kasası, ülkemizde ve dünyada yaygın olarak kullanılan ve yüksek sıkıştırma kapasitesini, basit ve kullanışlı bir şekilde bir araya getiren bir çözümdür. 7 ton kapasiteli kamyonlardan, 18 ton Kamyonlara ve 25 ton Kamyonlara kadar uygulaması yapılabilmektedir.

Modern şehirciliğin gereklerine uygun olarak geliştirilmiş araçlardır. Sefer başına taşınan çöp miktarını artırmak, çöp toplama süresini azaltmak ve operatörlerine esneklik sağlamak üretimin

Özellikler	SRT-HCA 7	SRT-HCA 10	SRT-HCA 12	SRT-HCA 14
Kapasite	7+1 m ³	10+1 m ³	12+1 m ³	14 + 1 m ³
Sıkıştırma Oranı	1:3	1:6	1:6	1:6
Yükleme Kapasitesi	7 m ³	10 m ³	12	14
Yükleme Tipi	Manuel / Otomatik	Manuel / Otomatik	Manuel / Otomatik	Manuel / Otomatik

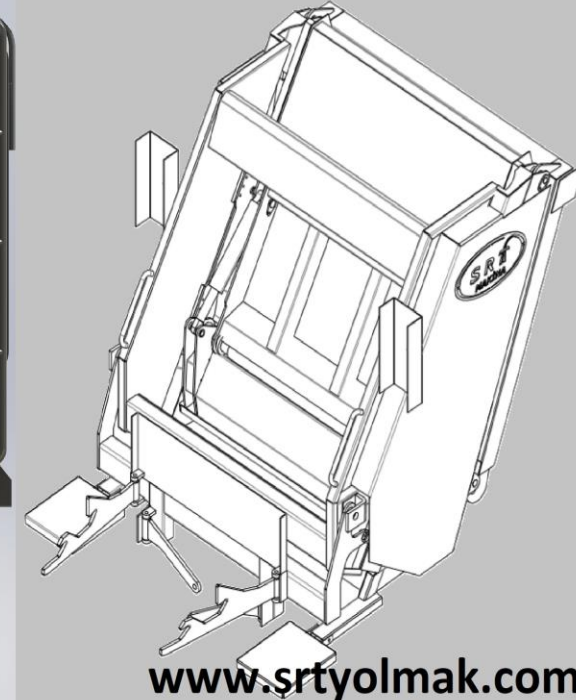

HYDRAULIC COMPRESSED WASTE BIN



Hydraulic Compression Garbage Container is a solution that is widely used in our country and in the world and combines high compression capacity in a simple and convenient way. It can be applied up to 7 tons capacity trucks, 18 tons trucks and 25 tons trucks. They are developed in accordance with the requirements of modern urbanism. The main purpose of production is to increase the amount of garbage transported per time, reduce waste collection time and provide flexibility to operators.

Features	SRT-HCA 7	SRT-HCA 10	SRT-HCA 12	SRT-HCA 14
Capacity	7+1 m ³	10+1 m ³	12+1 m ³	14 + 1 m ³
Compression Ratio	1:3	1:6	1 : 6	1 : 6
Loading Capacity	7 m ³	10 m ³	12	14
Loading Type	Manual / Automatic	Manual / Automatic	Manual / Automatic	Manual / Automatic

